

Away from the Desk

soft seating



Product Information

Away from the Desk is a soft upholstery system which answers the needs of our rapidly changing workplace as we migrate away from the predominance of the personal desk, with its fixed and tethered technology.

Individual spaces seamlessly integrate with larger, more collaborative working configurations, at lounge, table or café height. Facilitating, both concentrated personal work and collaborative team work.

Away from the Desk

Standard Product Information

Frame: FSC Plywood & FSC Hardwood frame with glued & screwed units.

Seat & back: Elasticated sprung seat & foam back.

Foam: Vitafoam Reflex.

Glides: Adjustable & linkable glides with non-marking elastomer foot.

Table tops: Melamine with chamfered edge as standard.

Table top finishes: White / Maple / Oak / Cherry / Walnut.

Base finishes: Black / RAL 9006.

(Steel bases)

N.B. Mandatory installation is required by Orangebox for AFTD configurations and recommended for AFTD freestanding units.

Optional Upcharges

Media accessories

(Where applicable)

Power & data













































(Where applicable)

Black foot & chrome column

(Steel bases)









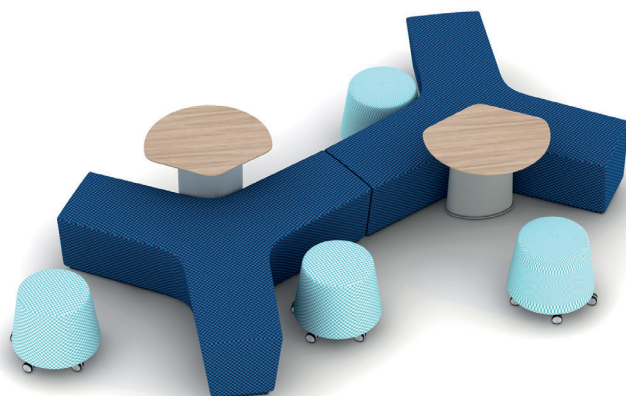











Modular units

AD-01  800 [31] 470 [19]	AD-02  800 [31] 820 [32]	AD-03  800 [31]	AD-03 LC  800 [31]	AD-03 RC  800 [31] 1470 [58]	
AD-11  1800 [71] 470 [19]	AD-12  1800 [71] 820 [32]	AD-13  1800 [71]	AD-13 LC  1800 [71]	AD-13 RC  1800 [71] 1470 [58]	
AD-21  1985 [78] 470 [19]	AD-22  2130 [84] 820 [32]	AD-23  2185 [86]	AD-23 LC  2160 [85]	AD-23 RC  2130 [84]	AD-23 DC  2160 [85] 1470 [58]
AD-24  1985 [78] 820 [32]	AD-25  1985 [78]	AD-25 LC  1985 [78]	AD-25 RC  1985 [78]	AD-25 DC  1985 [78] 1470 [58]	
AD-31  1985 [78] 470 [19]	AD-32  1985 [78] 820 [32]	AD-33  1985 [78]	AD-33 LC  1985 [78]	AD-33 RC  1985 [78]	AD-33 DC  1985 [78] 1470 [58]
AD-41  1295 [51] 470 [19]	AD-42  1445 [57] 820 [32]	AD-43  1495 [59]	AD-43 LC  1495 [59]	AD-43 RC  1495 [59]	AD-43 DC  1495 [59] 1470 [58]
AD-51  1627 [64] 470 [19]	AD-52  1835 [72] 820 [32]	AD-53  1900 [75]	AD-53 LC  1865 [73]	AD-53 RC  1865 [73]	AD-53 DC  1835 [72] 1470 [58]
AD-54  1425 [56] 470 [19]	AD-55  1635 [64] 820 [32]	AD-56  1710 [67]	AD-56 LC  1670 [66]	AD-56 RC  1670 [66]	AD-56 DC  1635 [64] 1470 [58]



mm["]











Modular arms & tables

AD-61 LA  275 [111]	AD-61 RA  275 [111]	AD-62 LC  780 [31]	AD-62 RC  780 [31]	AD-63 LP  900 [35]	AD-63 RP  900 [35]	
		700 [28]			725 [29]	
AD-64 SRO  1100 [43]	AD-64 MRO  1200 [47]	AD-64 LRO  1400 [55]	AD-64 SW  1450 [57]	AD-64 LW  1655 [65]	AD-64 120  1465 [58]	AD-64 HE  2170 [85]
						730 [29]
AD-65 RE  650 [26]	AD-65 OV  900 [35]	AD-66 RE  650 [26]	AD-66 OV  900 [35]	AD-67 RE  950 [37]	AD-67 SQ  750 [29]	
	1050 [41]				730 [29]	











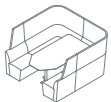

Dedicated tables

AD-71  600 [26]	AD-72  800 [31]
	730 [29]



Media & Workspaces

AD-81 DS  1300 [51]	AD-81 OV  1300 [51]	AD-81 GR  1650 [65]	AD-81 GT  1310 [52]
			1465 [57]
AD-81 HE120  2170 [85]	AD-81 HE90  1675 [66]	AD-82 DS  1300 [51]	AD-82 OV  1300 [51]
	1455 [57]		1775 [70]













Groups

AD-83 LS  1470 [58]	AD-83 RS  1470 [58]	AD-84 LS  1470 [58]	AD-84 RS  1470 [58]	AD-85  1470 [58]	AD-86 LH  1580 [62]	AD-86 RH  1580 [62]
				1470 [58]		
AD-87 C  2700 [106]	AD-87 S  2990 [118]	AD-88 C1  2990 [118]	AD-88 C2  3700 [146]	AD-88 C3  3300 [130]	AD-88 C4  3300 [130]	
						1470 [58]

Stand alone tables

AD-91 SRO  1200 [47]	AD-91 LRO  1400 [55]	AD-92  600 [24]
		730 [29] 500 [20]

Detached seating

AD-101  1035 [41]	AD-101 LT  1035 [41]	AD-101 RT  1035 [41]	AD-102  1140 [45]	AD-102 LT  1140 [45]	AD-102 RT  1140 [45]
		820 [32]			1470 [58]
AD-103  1835 [72]	AD-103 LT  1940 [76]	AD-103 RT  1835 [72]	AD-104  1035 [41]	AD-104 LT  1940 [76]	AD-104 RT  1940 [76]
		820 [32]			1470 [58]

